

Time for Progress...

Wedge wire screens & tubes

Solutions for technical screens and sieves

Pro - SLOT[®]



Producer of industrial screens

25 years of experience
in designing and
manufacturing of
wedge wire screens

Best quality assurance Manufactured in the European Union

www.progress-screens.com

Progress Eco

Progress Eco is a producer of industrial sieves and related products, including centrifuge baskets, filter elements, and other appliances. Since 1982 we produce products for mechanical filtration, separation, dehydration, and classification processes in many branches of the industry. Our comprehensive programme, state-of-the-art and advanced machinery stock, as well as technical advisory, and services support guarantee providing only the best solutions regardless of their application or work parameters.

Progress Eco employs over 200 workers, has 3 production plants in Poland, owns companies in Germany and the Czech Republic, as well as an expanded network of sales offices and merchants in Europe and worldwide.

The best quality is certified by international standards, patents, and utility models for products in offer.



Wedge wire Pro-SLOT®

Welded Pro-SLOT® slotted sieves are the main and the most technologically advanced line of our products. They are reliable for using in numerous filtration processes for solid and liquid particles. We manufacture them from profiled wires of high quality stainless and acid-proof steel. The technology of electrofusion used for joining profiled wires for a set of supporting rods lets us obtain extremely precise dimensions of apertures.

They work extremely well both in static structures, as well as dynamic ones, providing optimal effectiveness of a process even in tough and aggressive work environment. Depending on individual applications, our company offers flat welded or round welded sieves of different size and shape, types of fittings, with a possibility to join individual elements into larger segments.



Characteristics of Pro-SLOT® wedge wire screens

Extended lifetime

- Slot does not change during abrasive operation on the screen surface

Increased efficiency

- Capability to withstand heavy loads
- High open area
- No clogging
- Perfectly smooth and flat surface
- High precision of execution
- Increased capacity and more precise separation, dewatering and filtration
- Self-cleaning effect
- Low pressure loss

High open area and strength parameter

- Proper size of profile wire
- Proper size of structural support wire
- Profile shape of working wires (type Sb, Sbb or special wires)

Increased economical effectiveness, lower cost

- Higher efficiency
- Permanence of exploited resources
- Reduced maintenance cost

APPLICATION

Gas and oil industries

Production of fuel and lubricants
Desulphurization
Drying of natural gas
Regeneration of catalysts
Catalytic reactors
Protection of fittings and compressors

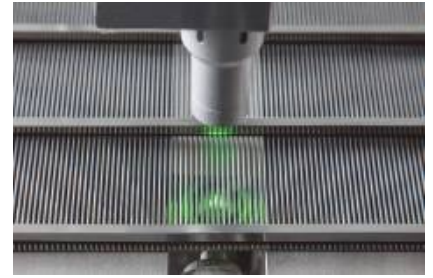

Chemical industry

Processing of paint and coating
Processing of chemicals
Processing of polymers
Purification of potassium
Purification of phosphates

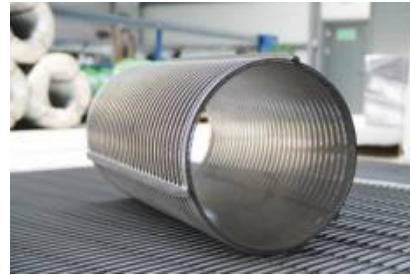

Mining

Coal enrichment



Food industry

Extraction
Fluidized beds
Absorption
Adsorption
Sorting
Drying

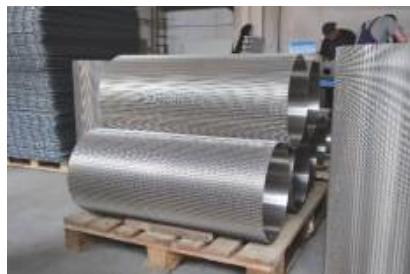

Paper

Coating
Blending
Dewatering
Refining

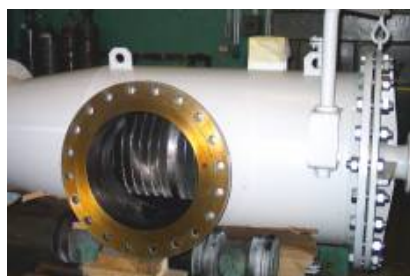

Water process

Municipal drinking water treatment
Waste water treatment
Industrial water treatment
Ion exchanger
Desalination of seawater
Irrigation



Mineral and aggregate processing

Exploitation of water
Exploitation of crude oil
Exploitation of natural gas
Recycling



Flat panels of wedge wire screens are manufactured by welding special profiled working wires to support wires at an angle of 90 degrees.

A precise slot is received by means of applying modern welding technology between working wires and support wires. The result is a rigid screen construction with the capability of withstanding heavy loads.

Innovative solutions of technology allows:

- to control quality of welding
- to use various working wires
- to design various slot sizes in one screen
- to design various support wires in one screen and
- various distances between support wires in one screen
- to gain superior flatness of sieves (no corrugation of working wires between support wires)

Slot: from 0,05 mm

Maximum size: 3500 x 4000 mm

Profile tilt: 0°-10°

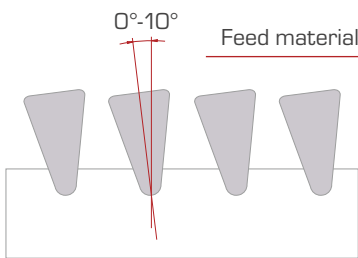

Standard tolerances*:

Length and width	
≤ 500 mm	± 2 mm
> 500 mm and ≤ 2000 mm	± 3 mm
> 2000 mm	± 4 mm
Slot opening	
± 0,050 mm	
max. deviation ± 0,100 mm	
Screen height	
± 0,3 mm	
Diagonal	
≤ 500 mm	± 2 mm
> 500 mm and ≤ 1000 mm	± 3 mm
> 1000 mm and ≤ 2000 mm	± 4 mm
> 2000 mm	± 5 mm
Flatness	
4,00 mm/m	
Straightness	
4,00 mm/m	

* Different set of tolerances needs individual agreement.

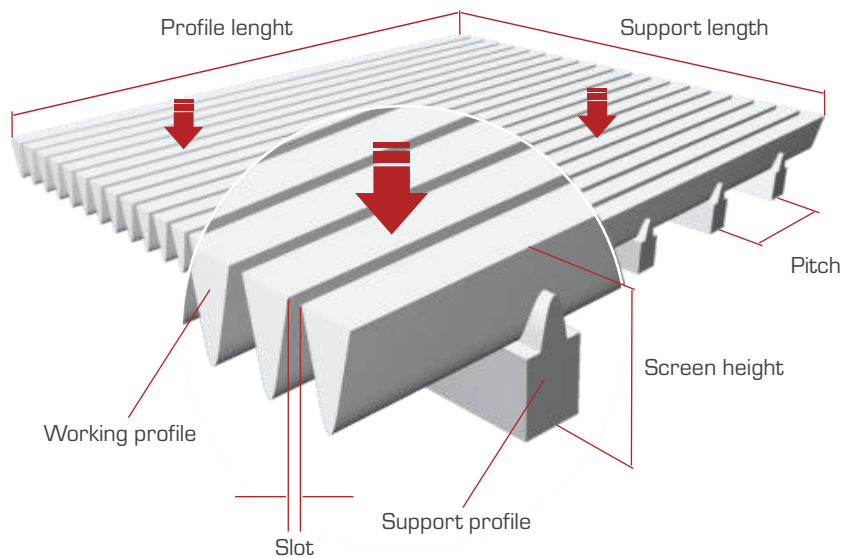

Support profile

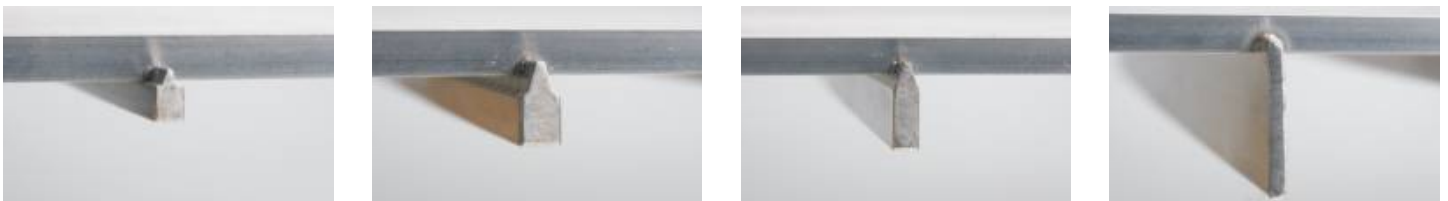

Technical parameters of support profiles available on page 6

Open area

An important parameter of the screen is the open area. Open area $F_o(\%)$ is the relation of the slot surface to the total screen surface. Open area is calculated according to the following formula:

$$F_o = S / (S + A) \times 100 (\%)$$

A - width of the working wire (according to the table of working wires)

S - slot size

For example:

A sieve was made of working wire Sb 28 with slot $s = 0,24$ mm

$$F_o = 0,24 / (0,24 + 2,2) \times 100\% = 9,6\%$$

Slot: from 0,02 mm

Maximum length: 6000 mm

Standard tolerances*:

Diameter		Slot opening
$\varnothing \leq 300$ mm	± 2 mm	$\pm 0,030$ mm
$\varnothing > 300$ mm	$\pm 2,5$ mm	max. deviation $\pm 0,100$ mm
Length		Screen height
$\varnothing \leq 300$ mm	± 2 mm	$\pm 0,4$ mm
$\varnothing > 300$ mm	± 4 mm	

* Different set of tolerances needs individual agreement

Cylindrical screens are received by simultaneously winding a spiral of profiled working wire and welding them to support wires, which are arranged along the axis of the cylindrical construction. This technology allows to provide welded profile wire screens for applications where high precision of the screen together with high strength is required.

Thanks to the newest welding technology we can provide:

- optional distance between support wires
- very precise and repeatable slot
- screens in accordance to special requests of our clients

OZ – circumferential slot, flow from outside to inside (FOTI)

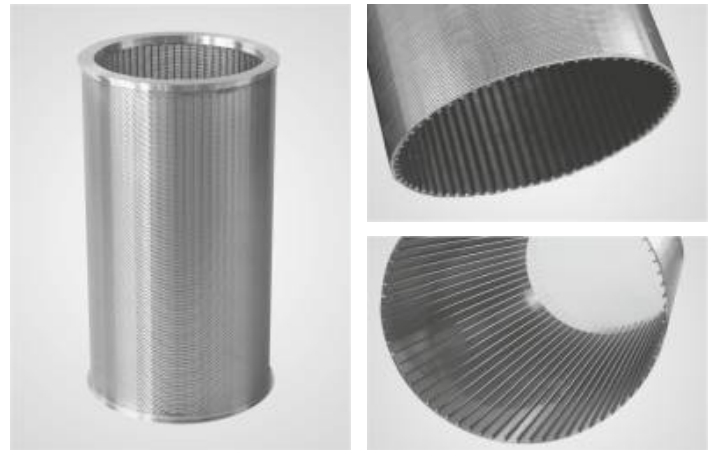
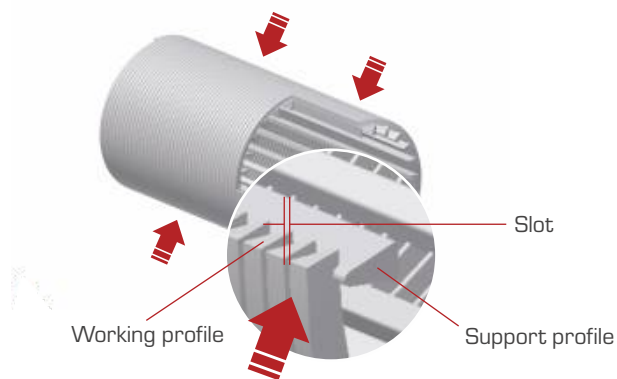

OZR – circumferential slot, flow from inside to outside (FITO)

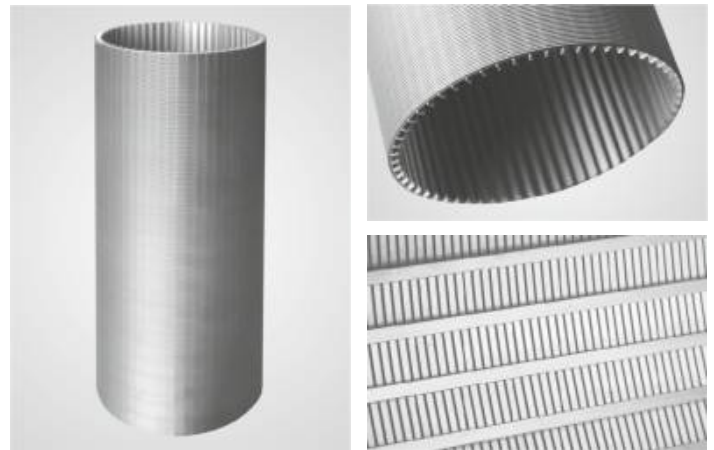
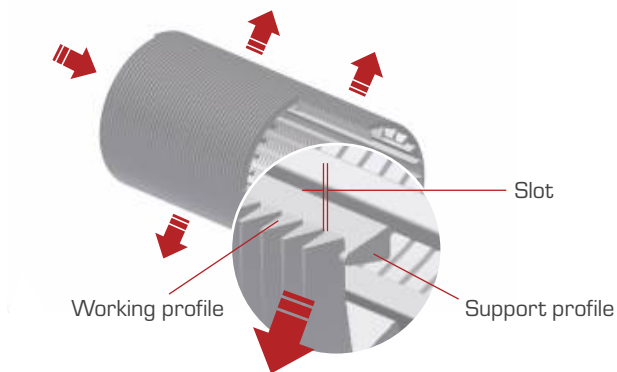

RW – slot parallel to the axis, flow from inside to outside (FITO)

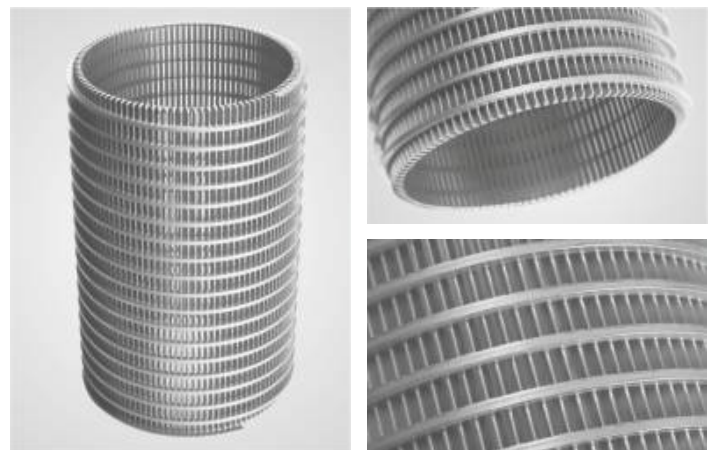
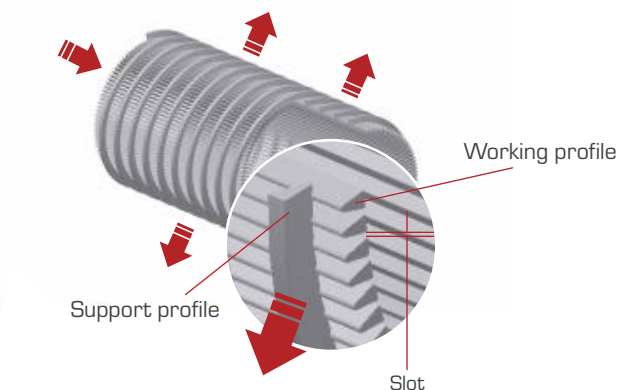

Flat sieves

Flat sieves are flat panels of welded profile wire, fixed to a frame and adapted to assembly. Depending on the kind of application, flat sieves can be divided into:

- **Sieves working in dynamic systems**
 - panels to be incorporated in vibrating sieves
 - special reinforcement depending on the sieve load is necessary
 - special finishing to guarantee secure, long working time, and proper fixing of the sieve to the application frame
- **Sieves working in static systems**
 - do not require any special reinforcements,
 - can work as bottoms and decks in tanks and storage reservoirs and sumps.

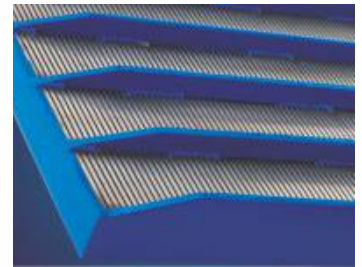
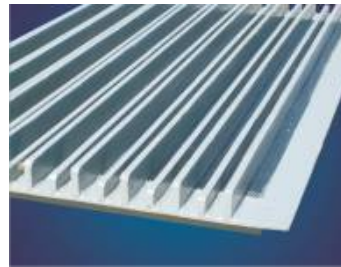
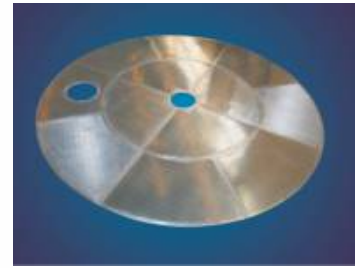
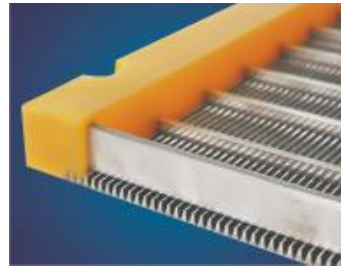

Arch sieves

Arch sieves are mainly used for dewatering and separation of solid particles from liquids. Depending on the application character, they can be divided into arch sieves with gravitational loading or arch sieves with pressured loading.

The application of arch sieve provides:

- uniform flow onto the sieve (usage of the whole sieve surface)
- high speed of flow onto the sieve
- increased classification effectiveness and efficiency (due to the possibility of applying the working wire at a defined angle relative to support wire).

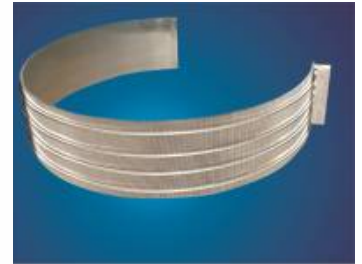
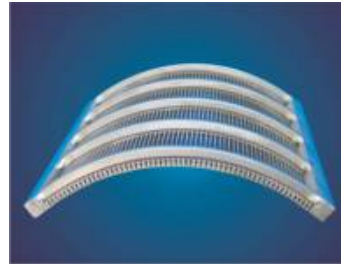

Gutter sieves

Gutter sieves are used as bottoms of screw conveyors, where in addition dewatering or separation is required apart from transportation.

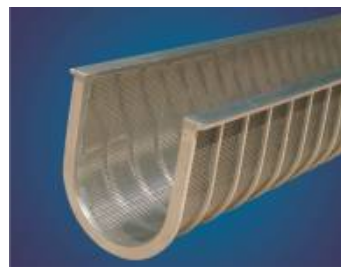

Conical sieves, baskets

Conical sieves and conical baskets are mainly used in centrifuges. They can be divided in two categories depending on their work character:

- **Working in dynamic system**
 - for all kinds of centrifuges,
 - with self supporting structure consisting of ribs, rings, flanges which constitute an integral part of the sieve construction. After a period of exploitation the whole basket has to be replaced:
 - without the supporting structure
 - as screening insert for non disposable structural frames. The only thing to be replaced is the screen insert.
- **Working in static systems- centrifugal dewatering screens**
 - filter cartridges
 - filter elements for pipelines.

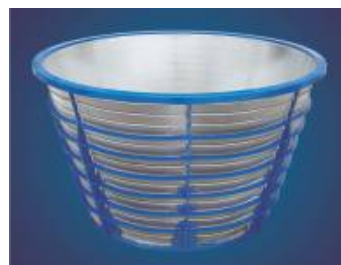

Others

Available on request

Working profiles

Type	A (mm)	B (mm)	$\alpha(^{\circ})$	$\beta(^{\circ})$
Type Sb				
Sb 6	0,50	1,20	12	
Sb 8	0,60	1,20	22	
Sb 10	0,75	1,30	20	
Sb 12	1,00	2,00	20	
Sb 18	1,50	2,50	23	
Sb 22	1,80	3,70	23	
Sb 28	2,20	4,50	23	
Sb 34	2,80	5,00	23	
Sb 42	3,40	6,50	23	
Sb 60	4,00	9,00	20	
Sb 70	5,00	10,00	24	
SbA 50	5,00	6,00	40	
Sb 55*	5,00	5,50	6	

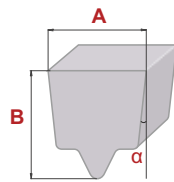
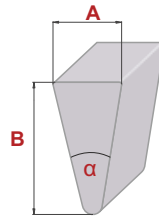

Other dimensions available on a special request

*Sb 55

Type Sbb	A	B	α	β
Sbb 34	2,20	5,00	23	4
Sbb 38	2,50	4,00	40	5
Sbb 42	2,80	6,50	23	4
Sbb 48	3,40	6,00	70	4
Sbb 50	3,50	8,00	23	4
Sbb 76	5,00	10,00	23	5
2,4 x 5	2,40	5,00	23	0
3 x 6,5	3,00	6,50	23	0

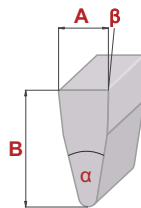

Other dimensions available on a special request

Special working wires separate highly abrasive materials. During their service the slot size does not increase considerably along with the abrasion of working surface. They are ideal for cylinder and conical sieves used in vibrating centrifuges. They increase the sieve's life span together with preventing clogging.

Support profiles

Type	A (mm)	B (mm)
Type I		
I 10 x 3	3,00	10,00
I 10 x 2	2,00	10,00
I 12 x 3	3,00	12,00
I 15 x 3	3,00	15,00
I 18 x 2	2,00	18,00
I 20 x 2	2,00	20,00
I 30 x 2	2,00	30,00
I 38 x 3	3,00	38,00

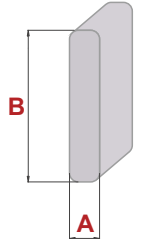

Other dimensions available on a special request

Type Q	A	B
Q 25	2,00	3,00
Q 35	3,00	5,00
Q 55	4,00	8,00

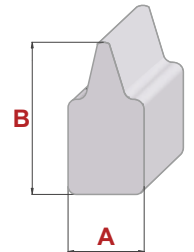

Other dimensions available on a special request

Type D	A	B
D 45	3,8	5,6

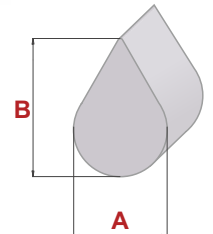

Other dimensions available on a special request

Standard materials

Structure	DIN	AISI/ASTM	UNI/DIN	BS	Anfor	Branding
Ferrite	1.4016	430	X8 Cr17			
Austenite	1.4301	304	X5 CrNi 1810	304 S 15	Z 6 CN 18.09	
	1.4307	304 L	X2 CrNi 1811	304 S 12	Z 2 CN 18.10	
	1.4373	202	X12CrMnNiN 18-9-5	-	-	
	1.4401	316	X5 CrNiMo 1712	316 S 16	Z 6 CND 17.11	
	1.4404	316 L	X2 CrNiMo 1712	316 S 12	Z 2 CND 17.12	
	1.4439	317 LN	X2 CrNiMoN 17-13-5	-	-	
	1.4539	904 L	X1 NiCrMoCuN 25205	S 31254	Z 1 NCOU 25.20	SMO 904
	1.4541	321	X6 CrNiTi 1811	321 S 12	Z 6 CNT 18.10	
	1.4571	316 Ti	X6 CrNiMoTi 1712	320 S 31	Z 6 CNDT 17.12	
Duplex	1.4462	329 LN	X2 CrNiMoN 2253	S32205	Z 2 CND 22.05 Az	SAF 2205
	1.4410	439	X2 CrNiMoN 2574	S32750	Z 3 CND 25.07 Az	SAF 2507
Others	2.4360		NiCu 30 FE	-	-	Monel 400
	2.4610		NiMo 16 Cr 16 Ti	-	-	Hastelloy C4
	2.4816		NiCr 15 Fe	-	-	Inconel 600
Carbon steel*	1.0038	A570 Gr 30	-	Fe 360 B FU	E 24 - 2NE	-
	1.0570	A572 Gr 50	-	Fe 510 D1 FF	E 36 - 3	-

* Available finishes: galvanized steel, Pro-Zinal (ZnAl), varnished steel
 ** Execution in other steel grades requires individual arrangement.



COMPLETE PRODUCTION PROGRAMME OF TECHNICAL SCREENS



Wedge wire screens

- Slot: from 0,05 mm (50 micrometer)
- Max. size: 3500 x 4000 mm
- Material: stainless steel, carbon steel
- Wire: standard wire Sb type, special wire Sbb type



Wedge wire tubes

- Slot: from 0,02 mm (20 micrometer)
- Max. length: 6000 mm
- Material: stainless steel
- Internal and external flow

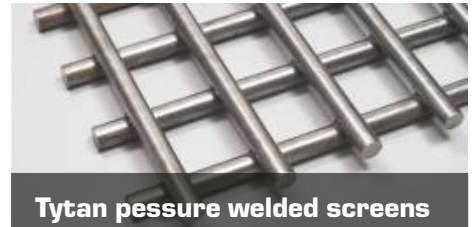

Tytan pressure welded screens

- Aperture: 7,0 - 200 mm
- Ø wire: 4,0 - 22,0 mm (simple, pressed, profiled HT i GZ)
- Width max. 1500 mm; Lenght - according to requirements
- Material: manganese steel (patent), stainless steel



Fine wire mesh

- Mesh: from 0,02 mm
- Type: simple weave (plain) and oblique wave screens
- Maximum width: 4000 mm
- Maximum length: 20000 mm

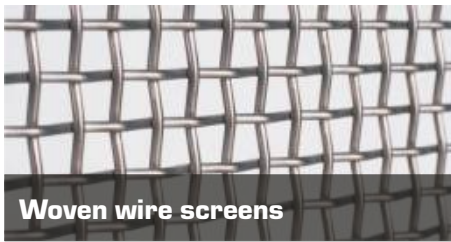

Woven wire screens

- Mesh: 1,0 - 100 mm
- Ø wire: 0,8 - 6,3 mm
- Material: spring/stainless/carbon steel, aluminium
- Available finishes: galvanized steel, Pro-ZINAL (ZnAl), varnished steel
- Maximum width: 4000 mm

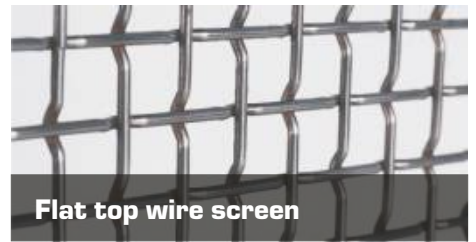

Flat top wire screen

- Mesh: 10,0 - 150 mm (square-shaped mesh)
- Ø wire: 2,5 - 12,0 mm
- Material: spring steel, stainless steel, carbon steel, aluminium
- Available finishes: galvanized steel, varnished steel

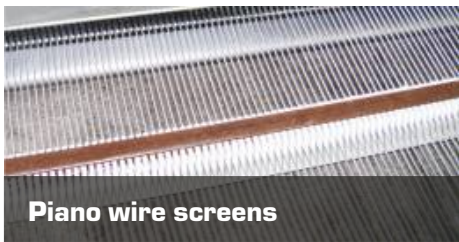

Piano wire screens

- Slot: 1,2 - 55,0 mm
- Ø wire: 0,8 - 8,0 mm
- Polyurethane and rubber lacings
- Max. width: 2000 mm
- Sheets with catches for longitudinal tension

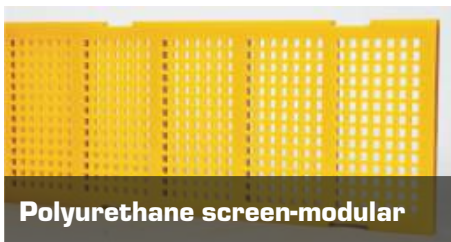

Polyurethane screen-modular

- System: Pro-LINE, Pro-CLEAT, Pro-CLIN, Pro-STEP, Pro-DECK
- Aperture: 0,25 - 160 mm
- Thickness: 30 - 60 mm
- Standard: 300 x 1000 mm
- Polyurethane: 45-95°ShA



Polyurethane screen-tensioned

- System: Pro-FALC, Pro-MAT
- Aperture: 1,1 - 160 mm
- Thickness: 20 - 60 mm
- Max dimensions: 1900 x 3000 mm
- Polyurethane: 45-95°ShA

Certificates

Our team consists of experienced engineers and craftsmen with qualifications confirmed by European certification.

We apply a controlling system which is in accordance with procedures and instructions of the holding certificate of **Quality Management System ISO 9001**.

The Quality Management System:

is applicable to: design and manufacturing of welded profile wire screens, perforated screens, wire cloths, harped screens, polyurethane screens and products and devices with their application designed for process industry. Design and manufacture of machines, equipments, tanks and pressure vessels and process pipework. Manufacture of products using water-jet method.



Progress Eco Spółka z ograniczoną odpowiedzialnością S.K.A.
Dobrow 7, 28-142 Tuczepy, Poland

International Sales Working hours: Monday - Friday / 8:00-16:00 UTC+1
T: +48 41 346 50 06 (ext. 120) F: +48 41 346 50 08 E: sales@progress-screens.com

www.progress-screens.com

